





Mogi Mirim (SDMJ) Brazil 2023

Form A

Pilot ID

VWAC Unlimited Free Known

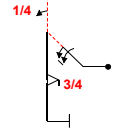
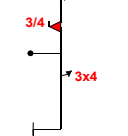
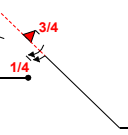
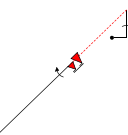
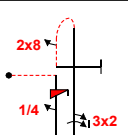
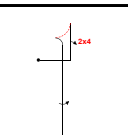
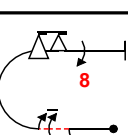
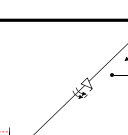
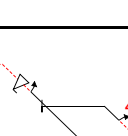
Flight #

No	Symbol	Cat. No.	K	Total K	Grade	Pos	Remarks	Item	K	Grade
1		5.3.2.1 9.1.2.6 9.1.1.1 9.9.5.3	24 12 6 11	53	.			Pos.		
								Harm.	0	
2		5.2.1.1 9.10.6.3 9.4.5.3	17 19 8	Fig A 44	.			Fig K	Total K	
								450	450	
3		1.2.7.1 9.2.1.4 9.10.4.3 9.1.4.5	13 13 13 9	Fig D 48	.			Penalties		
								Too Low		
								Too High		
								Interruptions		
								Insertions		
								Trg Violation		
								Wing Rocks		
Disqual Fig										
Other(note...)										
4		1.3.11.1 9.4.1.4 9.10.4.6 9.1.4.4	20 15 16 8	59	.			Final Freestyle		
								Duration	Min	Sec
5		8.8.3.4 9.12.1.4 9.1.5.1 9.2.1.6 9.8.5.1	20 7 2 17 3	Fig E 49	.					
6		6.2.2.1 9.4.1.2 9.1.5.4	15 9 8	32	.			Judges Details		
								Signature		
7		7.2.2.1 9.4.3.2 9.1.3.6 9.9.3.6 9.8.3.4	6 5 10 14 15	Fig B 50	.			Name		
								Number		
8		1.3.14.1 9.1.1.2 9.9.4.4 9.1.4.8	22 8 11 12	53	.					
9		8.4.16.4 9.9.9.4 9.1.4.2 9.8.2.2	14 13 4 9	Fig C 40	.					
10		2.2.5.1	22	22	.					

Pilot _____
A/C _____



Mogi Mirim (SDMJ) Brazil 2023

Form B

Pilot ID

VWAC Unlimited Free Known

Flight #

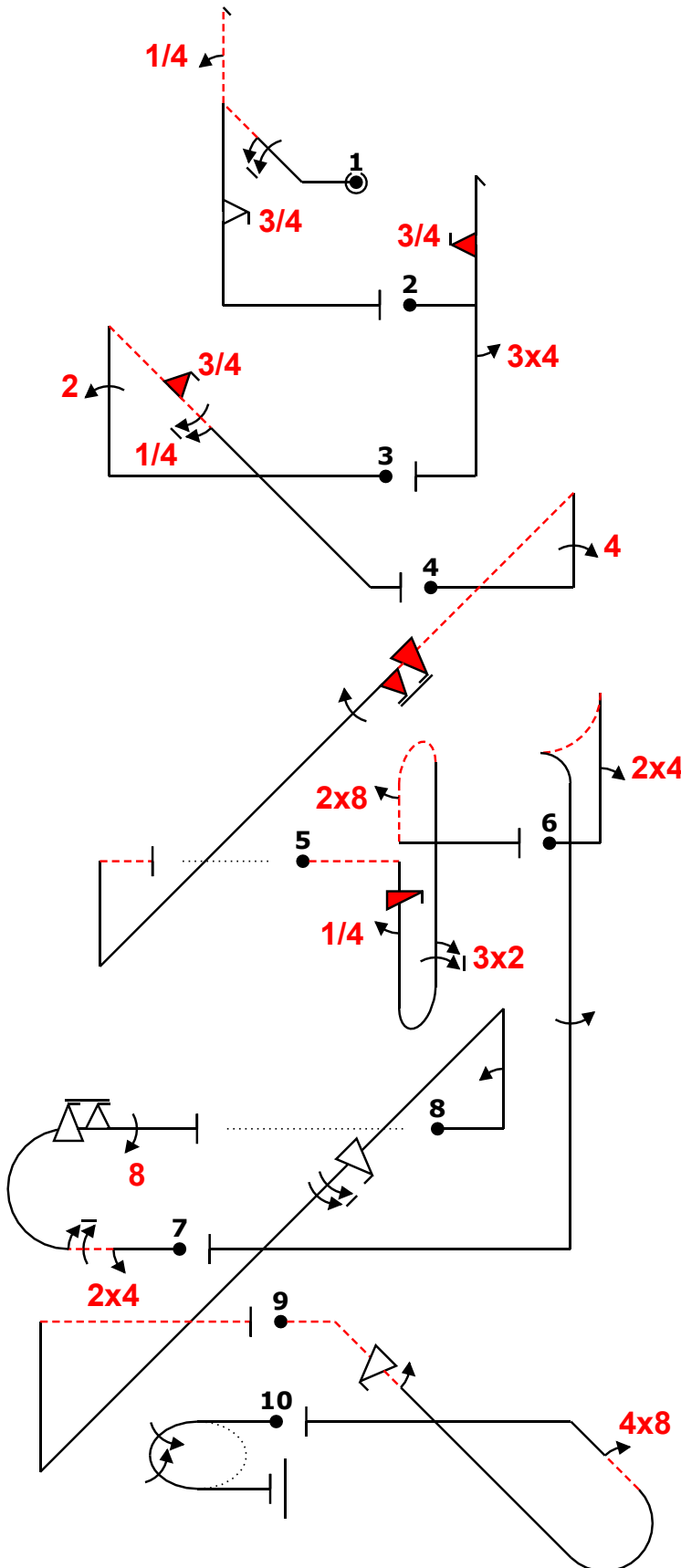
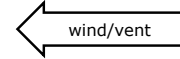

Power			
Fig	Aresti	K	
1	5.3.2.1	24	53
	9.1.2.6	12	
	9.1.1.1	6	
	9.9.5.3	11	
2 A	5.2.1.1	17	44
	9.10.6.3	19	
	9.4.5.3	8	
3 D	1.2.7.1	13	48
	9.2.1.4	13	
	9.10.4.3	13	
	9.1.4.5	9	
4	1.3.11.1	20	59
	9.4.1.4	15	
	9.10.4.6	16	
	9.1.4.4	8	
5 E	8.8.3.4	20	49
	9.12.1.4	7	
	9.1.5.1	2	
	9.2.1.6	17	
	9.8.5.1	3	
6	6.2.2.1	15	32
	9.4.1.2	9	
	9.1.5.4	8	
7 B	7.2.2.1	6	50
	9.4.3.2	5	
	9.1.3.6	10	
	9.9.3.6	14	
	9.8.3.4	15	
8	1.3.14.1	22	53
	9.1.1.2	8	
	9.9.4.4	11	
	9.1.4.8	12	
9 C	8.4.16.4	14	40
	9.9.9.4	13	
	9.1.4.2	4	
	9.8.2.2	9	
10	2.2.5.1	22	22
Total K = 450			

ed -2% 6dh(4).''3f.'''+++ "@A" 3ifh34.. "@D" ~++++22k`3if,5..'+` -3% +++44'n(....'6if'',1.....)~ (6,0) "@E" ~'is',4.'ibpb(''~
 ,32..''') ~~~~~,8'~> +,24' ita...'1.....++++~ "@B" 24,6m6f,88 (12,0) 2`pn(..f;9.....')~--- -2% "@C" ~,f,2.....irdb`',48''+
 +++ -2% 2j2

Pilot
A/C